

## Diade equipped troughs Gun Metal Fumè

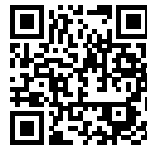

Equipped troughs

Code: 8100 136



### DETAILS

Edge/Installation Type Flush-mount | Top-mount | Undermount

Material AISI 304 stainless steel

Texture Brushed in line

Finish PVD

Coloring Gun Metal Fumè

Base 90 cm

External dimensions 320 x 164 mm

Internal dimensions 280 x 124 mm

Width 32 cm

Built-in hole

[View sink technical data sheet](#)

---

Standard fittings

Fixing hooks, gasket, drain, boxed packing

---

Waste fitting

1¼" drain

---

## FEATURES

GUN METAL FUMÈ

The Gun Metal Fumè finish is obtained by treating steel with a physical process called PVD (Physical Vacuum Deposition) which deposits particles of noble metals on the surface. The result is a unique and refined aesthetic effect, and an improvement of the mechanical properties of the steel which is more resistant to impact and scratches.

---

High thickness

1mm thick steel. A significant thickness, which guarantees the maximum sturdiness and durability.

---

## TECHNICAL DATA

8100 136

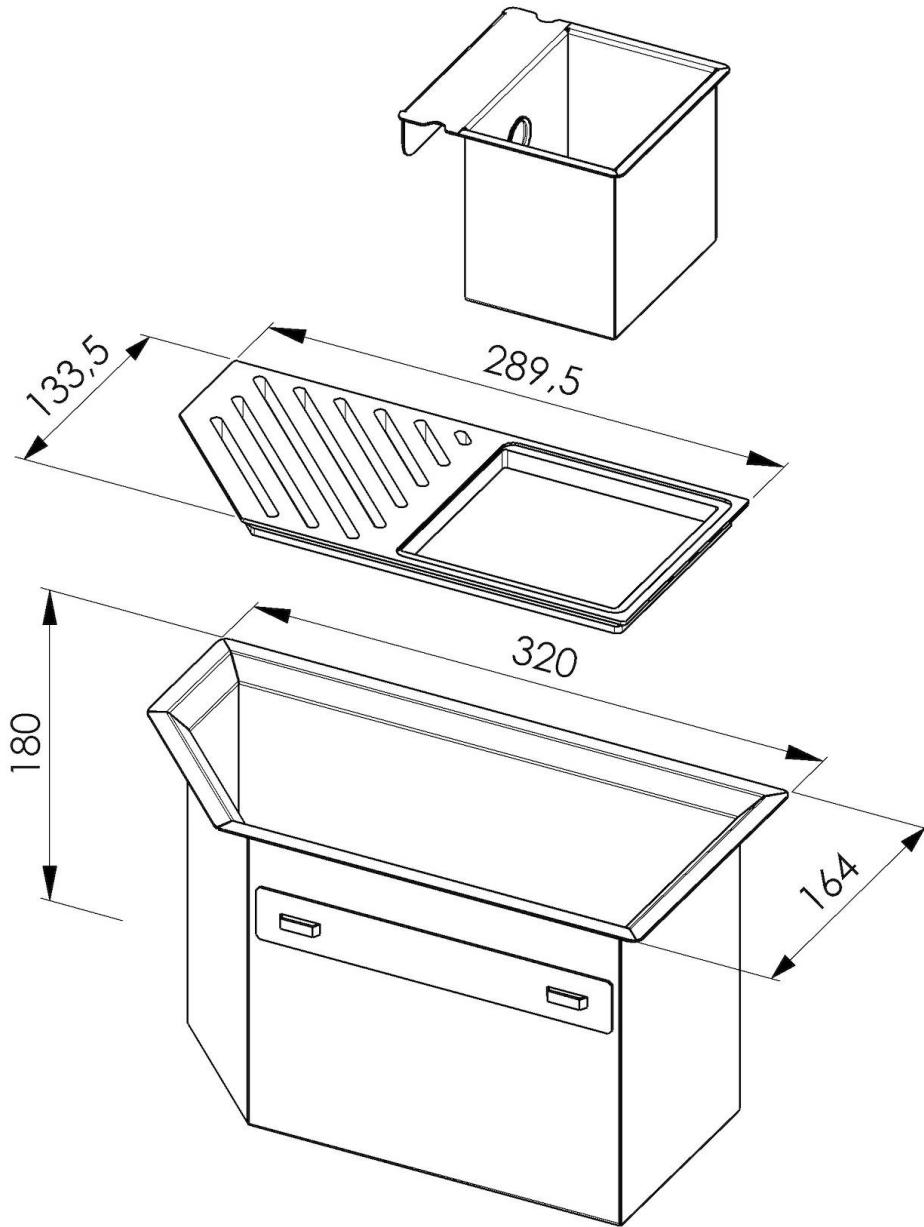

1 x Supporto black / 1 x Black support  
1 x Vaschetta AISI 304 / 1 x AISI 304 tray

## GALLERY

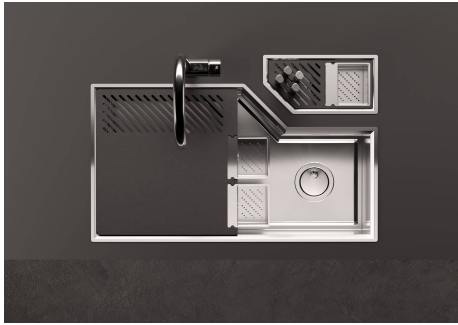

## RECOMMENDED PAIRINGS



**Sink Diade Gun Metal Fumè**  
3028 816



**Sink Diade Gun Metal Fumè**  
3028 016